

GENERAL NOTES:

- ALL WORK SHALL BE PERFORMED IN ACCORDANCE WITH THE CURRENT EDITION OF THE STANDARD SPECIFICATIONS FOR PUBLIC WORKS CONSTRUCTION, AND ANY AMENDMENTS HERETO, OTHER CITY STANDARDS, AND TO THE SATISFACTION OF THE CITY ENGINEER, OR HIS/HER DESIGNEE.
- ALL CONTRACTORS OR SUBCONTRACTORS THAT PERMITTEE ENGAGES FOR ANY OR ALL OF THE WORK TO BE COMPLETED BY THIS PERMIT SHALL HAVE A CITY BUSINESS LICENSE, LIABILITY INSURANCE, WITH THE CITY NAMED AS ADDITIONALLY INSURED, AND WORKERS COMPENSATION INSURANCE. THE LIABILITY INSURANCE SHALL HAVE A MINIMUM COVERAGE OF ONE MILLION DOLLARS PER INCIDENT AND TWO MILLION DOLLARS AGGREGATE AND INCLUDE AUTOMOBILE LIABILITY OF ONE MILLION DOLLARS.
- SIDE WALK RECONSTRUCTION SHALL BE FROM SCORE LINE TO SCORE LINE.
- STOCKPILING MATERIAL OR EQUIPMENT SHALL NOT BE ALLOWED IN THE THE PUBLIC STREET OR SIDEWALK UNLESS AUTHORIZED BY THE PUBLIC WORKS DIRECTOR/CITY ENGINEER, OR HIS/HER DESIGNEE.
- CONTRACTOR SHALL SUBMIT A TRAFFIC CONTROL PLAN FOR REVIEW AND APPROVAL BY THE CITY ENGINEER, OR HIS/HER DESIGNEE, PRIOR TO THE START OF ANY WORK.
- WORK HOURS SHALL BE RESTRICTED AND SHALL BE AS SHOWN ON THE TRAFFIC CONTROL PLAN.
- EXISTING TRAFFIC LOOPS, SIGNAL, LIGHTING, ELECTRICAL SYSTEM, AND UNDERGROUND INSTALLATIONS (WHETHER OR NOT PHYSICALLY MARKED OR SHOWN ON THE CONTRACT PLANS) DAMAGED BY THE CONTRACTOR'S OPERATION SHALL BE REPLACED OR RESTORED IN KIND OR BETTER AT THE PERMITTEE'S EXPENSE.
- CONTRACTOR SHALL CALL FOR INSPECTION AT (310) 253-5610 AT LEAST 24 HOURS IN ADVANCE.
- DIG ALERT SHALL BE NOTIFIED AT LEAST 48 HOURS PRIOR TO THE COMMENCEMENT OF EXCAVATION.
- PER §9.08.220, SECTIONS C AND D, OF THE CULVER CITY MUNICIPAL CODE THE APPLICANT SHALL PLANT TWO TREES FOR EVERY TREE THAT IS REMOVED AS PART OF THIS PROJECT. THE NEW TREES SHALL BE A MINIMUM 24" BOX SIZE AND SHALL BE OF A SPECIES AND PLANTED AT A LOCATION TO THE SATISFACTION OF THE CITY ENGINEER. THIS WORK MAY REQUIRE THE CONSTRUCTION OF TREE WELLS AND TREE GATES TO THE CULVER CITY STANDARDS.
- THE CONTRACTOR SHALL NOTIFY THE CITY AT LEAST TWO WORKING DAYS (48 HOURS) PRIOR TO CONSTRUCTION.
- THE CONTRACTOR SHALL UTILIZE BEST MANAGEMENT PRACTICES FOR THE CONTROL AND PREVENTION OF EROSION AND WASTE DISCHARGES FROM THE SITE.
- IT SHALL BE THE CONTRACTOR'S RESPONSIBILITY TO ARRANGE FOR AND COORDINATE THE RELOCATION OF ANY EXISTING UTILITIES DEEMED NECESSARY BY THE PROPOSED IMPROVEMENTS.
- THE CONTRACTOR SHALL BE RESPONSIBLE FOR PROTECTION OF EXISTING UTILITIES. ANY DAMAGE TO SUCH FACILITIES CAUSED BY HIS WORK SHALL BE REPAIRED BY THE CONTRACTOR AT HIS EXPENSE.
- THE CONTRACTOR SHALL MAINTAIN ADJACENT STREETS IN A NEAT, CLEAN, DUST FREE AND SANITARY CONDITION TO THE SATISFACTION OF THE CITY'S INSPECTOR. THE ADJACENT STREETS SHALL BE KEPT CLEAN OF DEBRIS, WITH DUST AND OTHER NUISANCES BEING CONTROLLED AT ALL TIMES. THE CONTRACTOR SHALL BE RESPONSIBLE FOR ANY CLEAN UP ON ADJACENT STREETS AFFECTED BY HIS CONSTRUCTION. STOCKPILING OF MATERIALS WITHIN THE PUBLIC RIGHT-OF-WAY IS NOT ALLOWED WITHOUT PRIOR WRITTEN APPROVAL OF THE CITY INSPECTOR.
- ALL SAWCUTS SHALL BE DONE BY THE WET-CUT METHOD, UNLESS OTHERWISE APPROVED BY THE ENGINEER, AND ALL SLURRY SHALL BE VACUUM REMOVED.
- CONSTRUCTION SHALL BE ADJUSTED AS NECESSARY TO MATCH EXISTING CONDITIONS, USES, AND PROVIDE POSITIVE SURFACE DRAINAGE. EXACT LIMITS AND CONFIGURATION OF WORK TO BE ADJUSTED AS DIRECTED BY THE ENGINEER IN THE FIELD.
- NO REVISIONS SHALL BE MADE TO THESE PLANS WITHOUT THE APPROVAL OF THE CITY ENGINEER.
- APPROVAL OF THIS PLAN BY THE CITY OF CULVER CITY DOES NOT CONSTITUTE A REPRESENTATION AS TO THE ACCURACY OF THE LOCATION OF OR THE EXISTENCE OR NON-EXISTENCE OF ANY UNDERGROUND UTILITY PIPE OR STRUCTURE WITHIN THE LIMITS OF THIS PROJECT. THIS NOTE APPLIES TO ALL PAGES.
- THE CONTRACTOR SHALL NOT DISCHARGE OR PERMIT TO BE DISCHARGED TO ANY STREET, STORM DRAIN, OR ANY APPURTANANCES THEREOF ANY NON-RAIN WATER OR OTHER LIQUID FROM THE PROJECT SITE OR FROM OPERATIONS PERTAINING TO THE PROJECT SITE PER NPDES PERMIT REGULATIONS AND THE CITY'S STORM WATER POLLUTION ORDINANCE NO. 96-031.
- THE CONTRACTOR SHALL PROTECT IN PLACE ALL EXISTING UTILITIES & UTILITY BOXES.
- CONTRACTOR SHALL EXECUTE DUE PRECAUTION DURING EXCAVATION ADJACENT TO EXISTING WATER LINE OR POWER POLES AND PROVIDE ADEQUATE SHORING AND/OR BRACING.
- VERIFICATION OF LOCATION AND DEPTH OF UNDERGROUND UTILITIES PRIOR TO CONSTRUCTION WILL BE THE SOLE RESPONSIBILITY OF THE CONTRACTOR. NONCOMPLIANCE OF VERIFICATION HOLDS KOA CORPORATION HARMLESS FROM ANY DAMAGES OR LOSSES INCURRED.

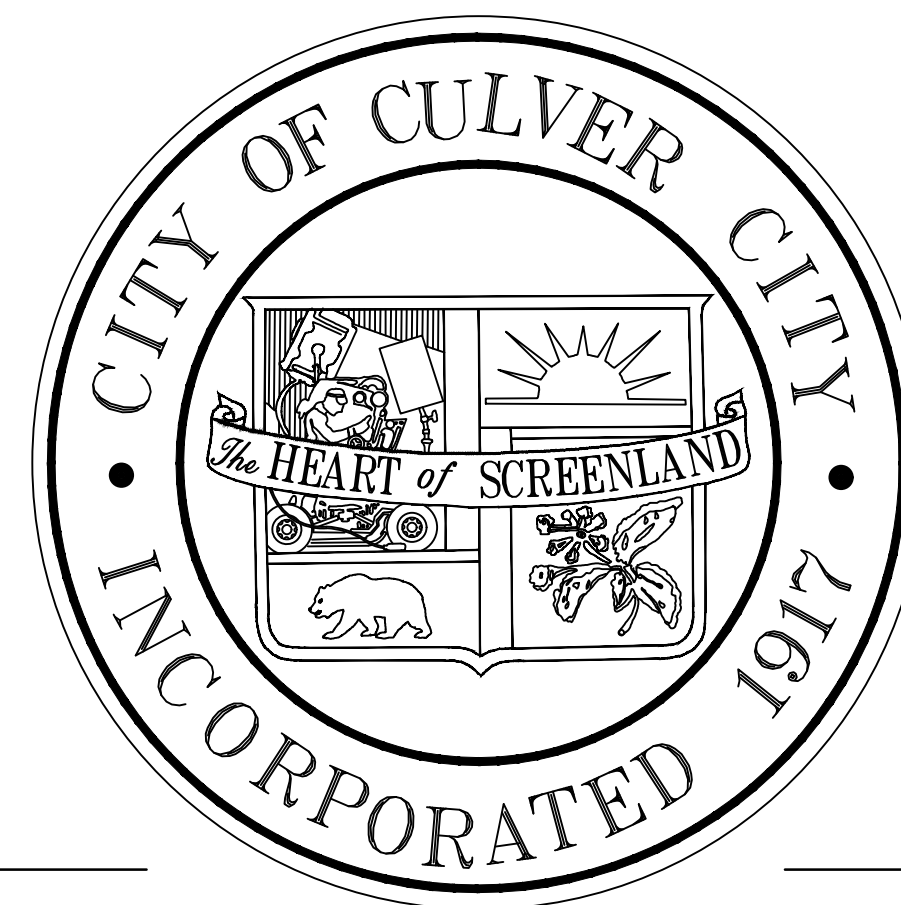

CITY OF CULVER CITY
PUBLIC WORKS DEPARTMENT
(310) 253-5600

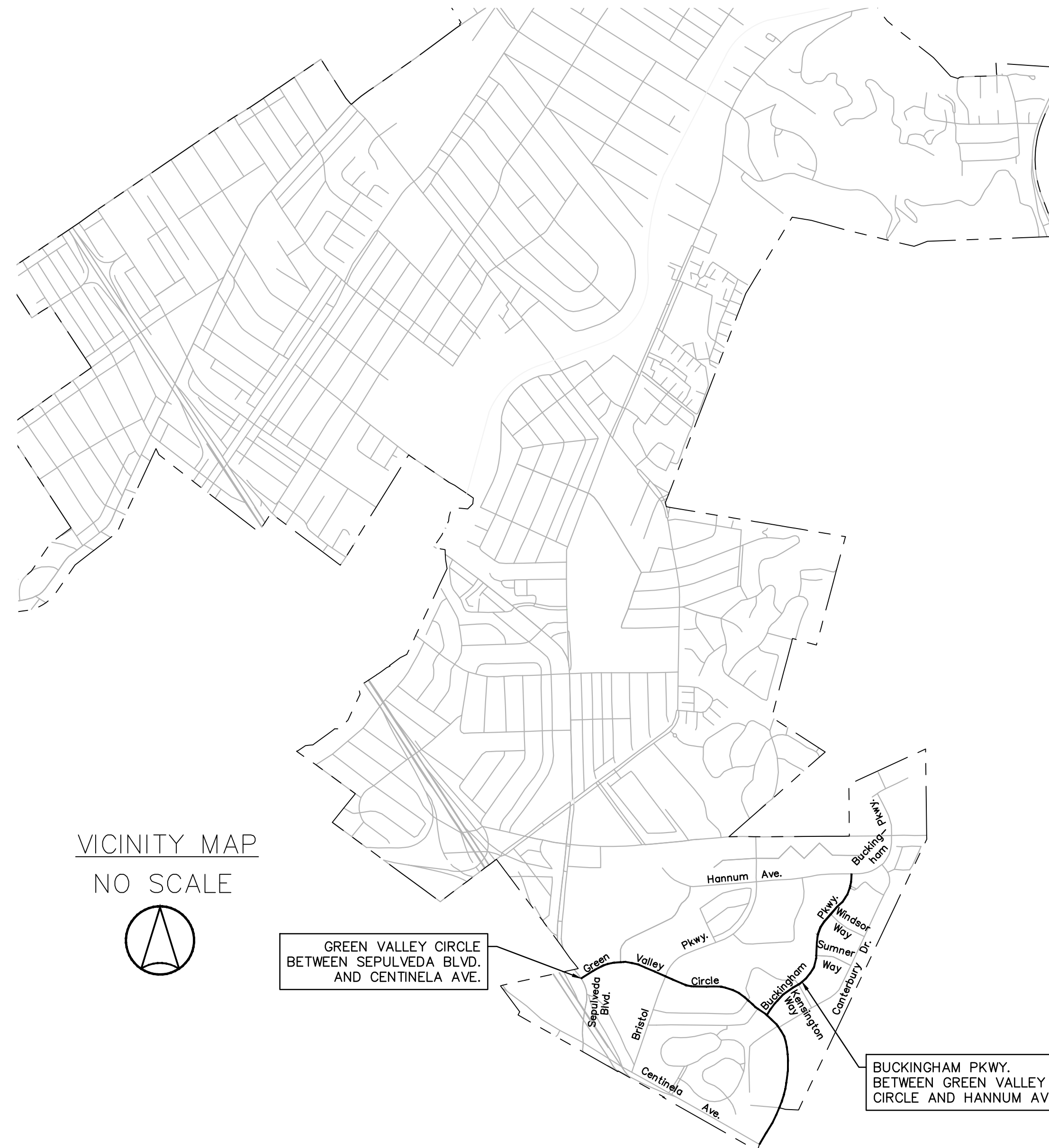

VICINITY MAP
NO SCALE

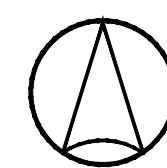

GREEN VALLEY CIRCLE
BETWEEN SEPULVEDA BLVD.
AND CENTINELA AVE.

BUCKINGHAM PKWY.
BETWEEN GREEN VALLEY
CIRCLE AND HANNUM AVE.

SHEET INDEX

TITLE SHEET AND GENERAL NOTES	SHEET 1-2
STRIPING DETAIL SHEET	SHEET 3
SIGNING AND STRIPING PLAN - GREEN VALLEY CIRCLE BETWEEN SEPULVEDA BLVD. AND CENTINELA AVE.	SHEET 4-8
SIGNING AND STRIPING PLAN - BUCKINGHAM PKWY. BETWEEN GREEN VALLEY CIRCLE AND HANNUM AVE.	SHEET 9-11

UTILITY COMPANY CONTACTS

COMPANY	CONTACT	PHONE NO.
UNDERGROUND SERVICE ALERT		1-800-227-2600
**SOUTHERN CALIFORNIA EDISON	MUDILA KANGULUNGU	(310) 315-3235
GOLDEN STATE WATER COMPANY	ELENA LOZANO	(562) 907-9200
AT&T TRANSMISSION	JOSEPH FORKERT	(714)-963-7964
CHEVRON PIPELINE COMPANY	DAVE ZERLER	(310)-669-4014
SHELL OIL PIPELINE COMPANY	KELLEY DAWSON	(310)-816-2063
MWD-SUBSTRUCTURES	DEYDRA LINARES	(213)-217-7670
MPOWER COMMUNICATIONS	MARK DENNINGS	(949)-864-0296
VERIZON	DENNIS HEROUX	(949)-417-7841
CROWN CASTLE	NICK BELINSKY	(724)-416-2449
TERADEX INC.	KEITH HOOPER	(650)-227-3254
CTLON-CENTURYLINK	GEORGE MCELVAIN	(303)-992-9931
**CLEAR CHANNEL OUTDOOR	FRED GARCIA	(213)-305-0045
**ANDEAVOR	CYNTHIA SMITH	(714)-880-1687
SOTHERN CALIFORNIA GAS CO.	AARON BELL	(310)-605-7918

UTILITY NOTICE

THE EXISTENCE OR LOCATION OF ANY UNDERGROUND UTILITIES, PIPES, STRUCTURES, ETC. WHICH WERE NOT VISIBLE FOR FIELD VERIFICATION AND ARE SHOWN ON THIS PLAN SET, WERE SHOWN FROM INFORMATION PROVIDED BY OTHERS NOT CONNECTED WITH KOA CORPORATION. THE UNDERGROUND UTILITIES ARE SHOWN FOR INFORMATION PURPOSES ONLY AND DO NOT REPRESENT PRECISE LOCATIONS OR DEPTHS. ANY CONSTRUCTION RELATIVE TO UNDERGROUND UTILITIES MUST REQUIRE THE CONTRACTOR OR OTHERS TO ASCERTAIN THE EXISTENCE OR THE TRUE LOCATION AND DEPTH OF ANY UNDERGROUND UTILITIES. VERIFICATION OF LOCATION AND DEPTH OF UNDERGROUND UTILITIES PRIOR TO CONSTRUCTION WILL BE THE SOLE RESPONSIBILITY OF THE CONTRACTOR. NONCOMPLIANCE OF VERIFICATION HOLDS KOA CORPORATION HARMLESS FROM ANY DAMAGES OR LOSSES INCURRED.

STANDARD DRAWINGS

	CA MUTCD	CALTRANS STD. PLANS	SPPWC
PAVEMENT MARKERS AND TRAFFIC LINES	FIG 3A-101(CA) THRU 3A-113(CA)	A20A THRU A20D	-
PAVEMENT MARKINGS ARROWS, SYMBOLS AND WORDS	FIG 3B-23(CA) THRU 3B-24(CA)	A24A THRU A24E	-

LEGEND

- = EXISTING STRIPING & MARKINGS TO REMAIN.
- = PROPOSED STRIPING & MARKINGS.
- = EXISTING SIGN AND POST.
 = EXISTING SIGN AND POST TO BE REMOVED OR RELOCATED.
 = PROPOSED SIGN AND POST.
- = EXISTING RED CURB MARKINGS TO REMAIN.
 = PROPOSED RED CURB MARKINGS.
- = SIGNALIZED INTERSECTION.
- = PROPOSED DIRECTIONAL ADA CURB RAMP
- = INSTALL BUS ISLAND (COMPATIBLE WITH CLASS IV BIKE LANE)
- = PROPOSED CONCRETE WORK
- = PROPOSED HIGH-VISIBILITY BICYCLE CROSSING
- = PROPOSED HIGH-VISIBILITY CROSSWALK



CITY OF CULVER CITY
PUBLIC WORKS DEPARTMENT
MOBILITY & TRAFFIC ENGINEERING DIVISION
FOX HILLS BIKEWAY IMPROVEMENTS PROJECT
TITLE SHEET

NO	DESCRIPTION	BY	AP	DATE



PLANS PREPARED BY:
WILLDAN Engineering *extending your reach*
13191 CROSSROADS PARKWAY NORTH
SUITE 405 INDUSTRY, CA 91746-3497
(962) 908-8200
UNDER THE SUPERVISION OF
JEFFREY C. LAU RCE 83887 DATE 12/12/24

DESIGNED BY MT	DATE 12/12/24	CHECKED BY THOMAS CHECK, PE, TE SENIOR TRAFFIC ENGINEER	DATE	SHEET 1	PROJECT NUMBER	PLAN NUMBER
DRAWN BY MT	DATE 12/12/24	APPROVED BY ANDREW MAXIMOUS, PE, TE MOBILITY & TRAFFIC ENGINEERING MANAGER	DATE	OF 11 SHEETS		

SIGNING AND STRIPING GENERAL NOTES:

- ALL MATERIAL AND WORK SHALL CONFORM TO THE MOST RECENT VERSION OF THE CALIFORNIA MANUAL ON UNIFORM TRAFFIC CONTROL DEVICES (CALIFORNIA MUTCD), 2015 STANDARD PLANS AND STANDARD SPECIFICATIONS OF THE CALIFORNIA DEPARTMENT OF TRANSPORTATION, FHWA STANADARD HIGHWAY SIGNS, CALIFORNIA SIGN SPECIFICATION, AND THE SPECIAL PROVISIONS.
- ALL STRIPING AND PAVEMENT LEGENDS SHALL BE ALKYD-BASED THERMOPLASTIC WITH RAISED PAVEMENT MARKERS UNLESS OTHERWISE NOTED.
- ALL CONFLICTING LINES AND LEGENDS SHALL BE REMOVED BY GRINDING. REMOVAL OF RAISED PAVEMENT MARKERS SHALL NOT CAUSE DAMAGE TO THE PAVEMENT SURFACE.
- ALL SALVAGED SIGNS AND POSTS SHALL BE DELIVERED TO THE CITY MAINTENANCE YARD, 9505 JEFFERSON BLVD, CITY OF CULVER CITY, (310) 253-6441, UNLESS OTHERWISE INDICATED.
- NEW SIGNS POSTS SHALL BE "UNISTRUT" SQUARE GALVANIZED STEEL POSTS WITH A BREAKAWAY FEATURE, OR APPROVED EQUAL.
- ALL NEW STREET NAME SIGNS SHALL BE DOUBLE-SIDED RETRO-REFLECTORIZED TYPE WITH A GREEN BACKGROUND AND A WHITE LEGEND. POST MOUNTED STREET NAME SIGNS SHALL USE 6 INCH UPPER CASE AND 4½ INCH LOWER CASE SERIES C LETTERS WITH THE CITY SEAL AND LOGO, AS PER CITY STANDARD PLAN. ALL OVERHEAD STREET NAME SIGNS SHALL USE 12 INCH UPPER CASE AND 9 INCH LOWER CASE SERIES C LETTERS WITH NO CITY SEAL OR LOGO. ALL NEWSIGNS ARE TO HAVE RETRO-REFLECTORIZED SHEETING WITH TYPE III BACKGROUNDS, TYPE VIII WHITE TEXT, AND UV/ANTI-GRAFFITI FILM.
- ALL SIGNS ARE TO BE PER THE STATE OF CALIFORNIA SIGN SPECIFICATIONS AND SHALL BE MINIMUM 0.1 INCH THICK ALUMINUM SHEETING.
- STRIPING SHALL BE MARKED OUT BY THE CONTRACTOR AND APPROVED BY THE CITY TRAFFIC ENGINEER PRIOR TO FINAL INSTALLATION. WHERE THE PROPOSED STRIPING HAS TAPERS, MARKOUT SHALL USE THE PAINT BRUSH-OVER-ROPE TECHNIQUE. MINIMUM OF ONE WEEK NOTICE REQUIRED BY THE CITY TRAFFIC ENGINEER FOR APPROVAL OF STRIPING.

TRAFFIC SIGNAL GENERAL NOTES:

- TRAFFIC SIGNAL EQUIPMENT AND THE INSTALLATION THEREOF SHALL CONFORM TO THE LATEST CALTRANS STANDARD PLANS AND SPECIFICATIONS OF THE CALIFORNIA DEPARTMENT OF TRANSPORTATION, AND TO THE MOST RECENT VERSION OF THE CALIFORNIA MANUAL ON UNIFORM TRAFFIC CONTROL DEVICES (CALIFORNIA MUTCD) THIS PLAN AND THE SPECIAL PROVISIONS.
- NEW CONDUIT SHALL BE 2" SCH 80 PVC AND PULL BOXES SHALL BE #6 UNLESS SHOWN OTHERWISE.
- IT SHALL BE THE RESPONSIBILITY OF THE CONTRACTOR TO VERIFY THE EXISTENCE AND LOCATION OF ALL UNDERGROUND FACILITIES AND TO PROTECT THEM FROM DAMAGE. THE CONTRACTOR SHALL BEAR THE TOTAL EXPENSE OF REPAIR OR REPLACEMENT OF ANY UNDERGROUND FACILITIES DAMAGED DURING CONSTRUCTION.
- ANY MODIFICATION OF OR CHANGES TO APPROVED PLANS MUST BE APPROVED BY THE CITY ENGINEER.
- LOCATION OF UNDERGROUND FACILITIES ARE APPROXIMATE THE CONTRACTOR SHALL POTHOLE TO DETERMINE THE EXACT LOCATION AND VERIFY ALL CONDITIONS ON THE JOBSITE.
- THE CONTRACTOR SHALL EXERCISE EXTREME CARE TO AVOID DAMAGING EXISTING UTILITIES BY LOCATING ALL UTILITIES PRIOR TO CONSTRUCTION HAND DIG FOUNDATIONS UNTIL CLEAR OF OBSTRUCTION COORDINATE POLE INSTALLATION WITH OVERHEAD UTILITY AND SUBSTRUCTURE OWNERS CONTACT UNDERGROUND SERVICE ALERT AT (800) 422-4133 48 HOURS PRIOR TO CONSTRUCTION.
- CONTRACTOR SHALL COVER PEDESTRIAN INDICATIONS WHEN APPLICABLE CROSSWALK IS CLOSED DURING CONSTRUCTION.
- CONTRACTOR SHALL FURNISH AND INSTALL TEMPORARY EQUIPMENT NECESSARY TO MAINTAIN CURRENT SIGNAL OPERATION INCLUDING BUT NOT LIMITED TO CONTROLLER ASSEMBLIES AND SIGNAL POLES.
- INDUCTIVE DETECTOR LOOPS SHALL BE 6' DIAMETER TYPE "E" AND CENTERED IN TRAVEL LANE.

RECTANGULAR RAPID FLASHING BEACON GENERAL NOTES:

- RECTANGULAR RAPID FLASHING BEACONS, SIGNING AND STRIPING, AND THE INSTALLATION THEREOF SHALL CONFORM TO CALTRANS REVISED STANDARD PLANS AND SPECIFICATIONS, DATED 2018, THE 2014 CALIFORNIA MANUAL ON UNIFORM TRAFFIC CONTROL DEVICES (CA MUTCD), LATEST EDITION, THIS PLAN AND THE SPECIAL PROVISIONS.
- ALL MATERIALS AND EQUIPMENT SHALL BE FURNISHED AND INSTALLED BY THE CONTRACTOR.
- IT SHALL BE THE RESPONSIBILITY OF THE CONTRACTOR TO VERIFY THE EXISTENCE AND LOCATION OF ALL UNDERGROUND FACILITIES, AND TO PROTECT THEM FROM DAMAGE. THE CONTRACTOR SHALL BEAR THE TOTAL EXPENSE OF REPAIR OR REPLACEMENT OF ANY UNDERGROUND FACILITIES DAMAGED DURING CONSTRUCTION.
- LOCATION OF UNDERGROUND FACILITIES ARE APPROXIMATE. THE CONTRACTOR SHALL POTHOLE TO DETERMINE THE EXACT LOCATION AND VERIFY ALL CONDITIONS ON THE JOBSITE PRIOR TO ORDERING POLES.
- THE CONTRACTOR SHALL EXERCISE EXTREME CARE TO AVOID DAMAGING EXISTING UTILITIES BY LOCATING ALL UTILITIES PRIOR TO CONSTRUCTION HAND DIG FOUNDATIONS UNTIL CLEAR OF OBSTRUCTION COORDINATE POLE INSTALLATION WITH OVERHEAD UTILITY AND SUBSTRUCTURE OWNERS CONTACT UNDERGROUND SERVICE ALERT AT (800) 422-4133 48 HOURS PRIOR TO CONSTRUCTION.
- ANY MODIFICATION OF OR CHANGES TO APPROVED PLANS MUST BE APPROVED BY THE CITY ENGINEER.
- OBTAIN APPROVAL FOR EXACT SIGNAL EQUIPMENT LOCATIONS WITH THE ENGINEER IN THE FIELD PRIOR TO FINAL PLACEMENT.
- BEACONS SHALL BE YELLOW RECTANGULAR RAPID FLASHING BEACONS WITH PEDESTRIAN VISIBLE INDICATIONS.
- PEDESTRIAN PUSH BUTTONS SHALL BE AN ACCESSIBLE PEDESTRIAN SIGNAL (APS) WITH DIRECTIONAL ARROW AND R10-25 SIGNS.
- ALL CONNECTIONS THROUGH POLES SHALL BE PROTECTED WITH BUSHINGS OR CONDULETS.
- ALL POLE MOUNTED EQUIPMENT SHALL BE BOLTED TO POLE.
- ALL STRIPING, ARROWS AND PAVEMENT MARKINGS SHALL BE THERMOPLASTIC WITH WET NIGHT VISIBILITY.
- REMOVAL OF CONFLICTING STRIPING SHALL BE BY GRINDING METHOD. STRIPING REMOVALS SHALL INCLUDE REMOVAL OF PAVEMENT MARKERS.

CITY OF CULVER CITY
PUBLIC WORKS DEPARTMENT
MOBILITY & TRAFFIC ENGINEERING DIVISION
FOX HILLS BIKEWAY IMPROVEMENTS PROJECT
GENERAL NOTES



NO	DESCRIPTION	BY	AP	DATE

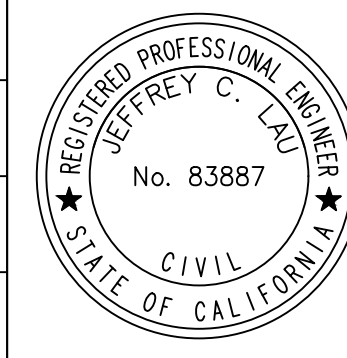

PLANS PREPARED BY:
WILLDAN Engineering *extending your reach*
13191 CROSSROADS PARKWAY NORTH
SUITE 405 INDUSTRY, CA 91746-3497
(926) 908-8200

UNDER THE SUPERVISION OF
JEFFREY C. LAU RCE 83887 DATE 12/12/24

DESIGNED BY MT	DATE 12/12/24	CHECKED BY THOMAS CHECK, PE, TE SENIOR TRAFFIC ENGINEER	DATE	SHEET 2	PROJECT NUMBER	PLAN NUMBER
DRAWN BY MT	DATE 12/12/24	APPROVED BY ANDREW MAXIMOUS, PE, TE MOBILITY & TRAFFIC ENGINEERING MANAGER	DATE	OF 11 SHEETS		

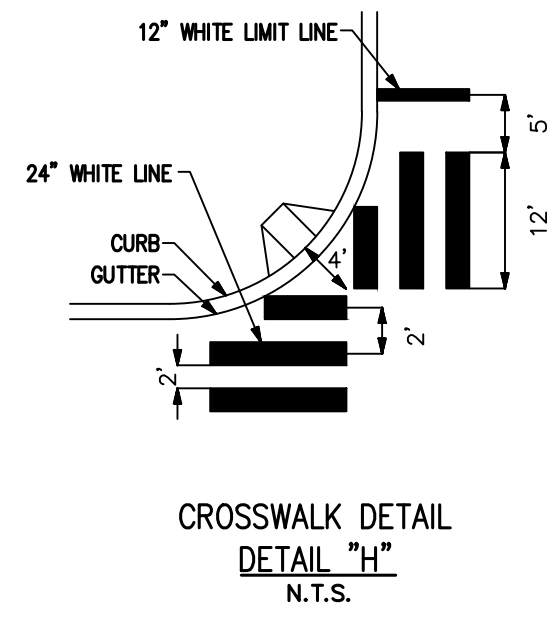
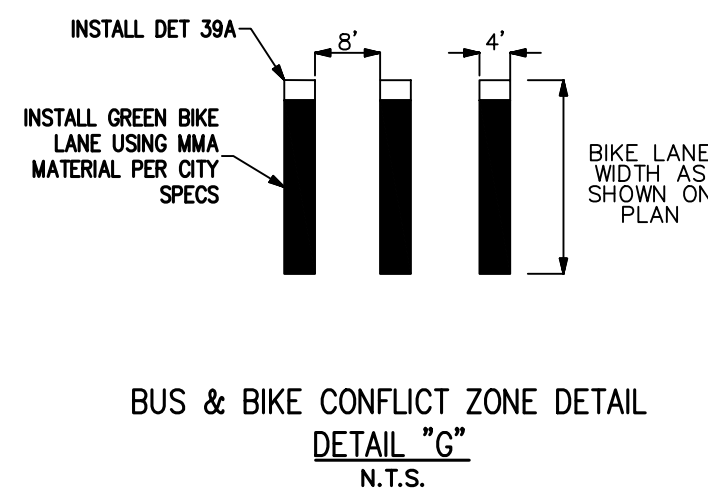
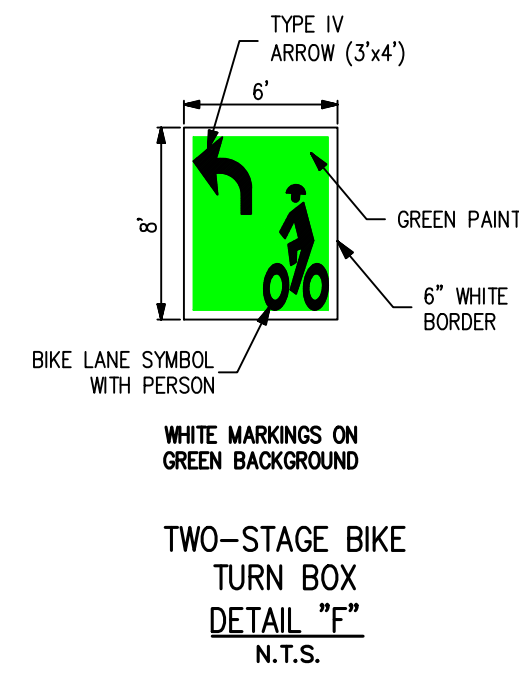
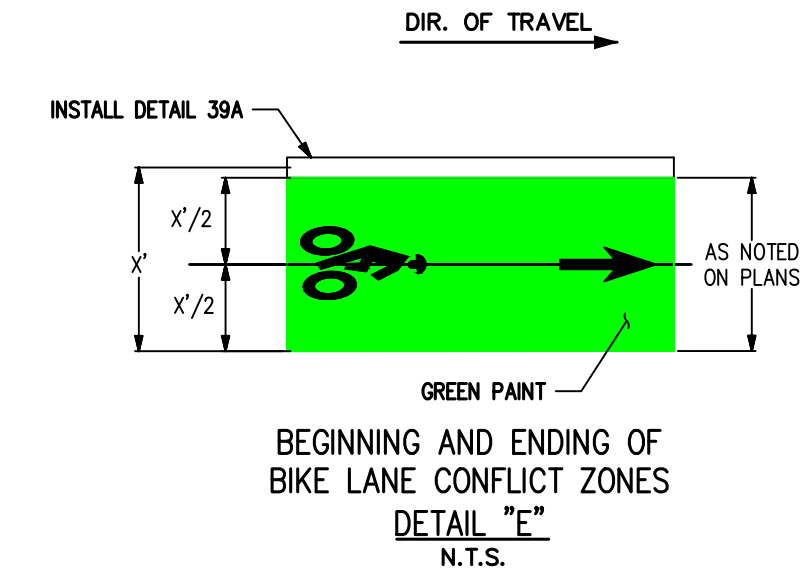
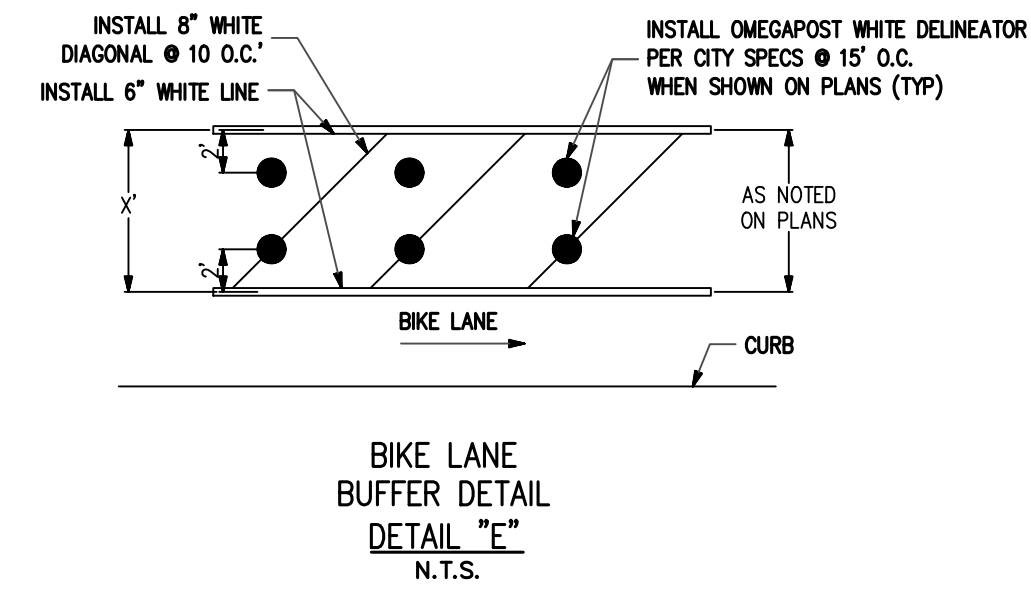
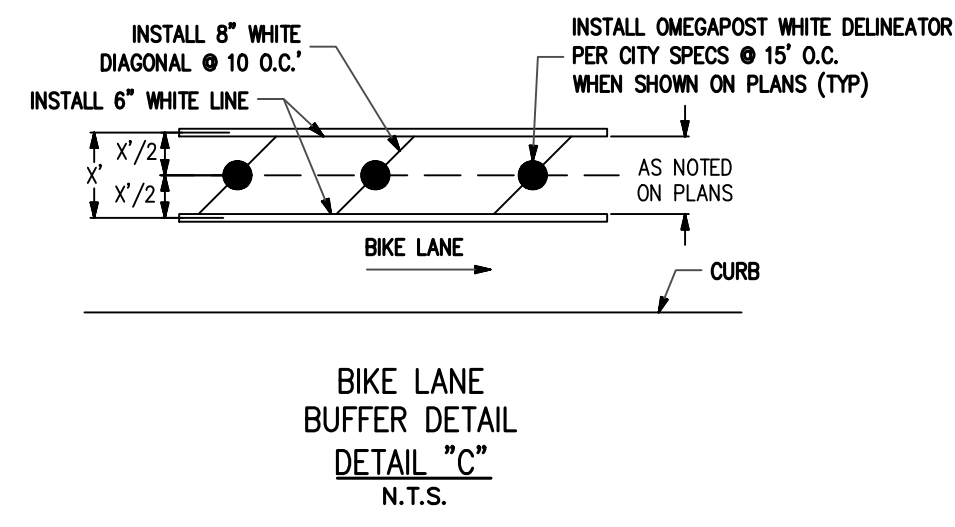
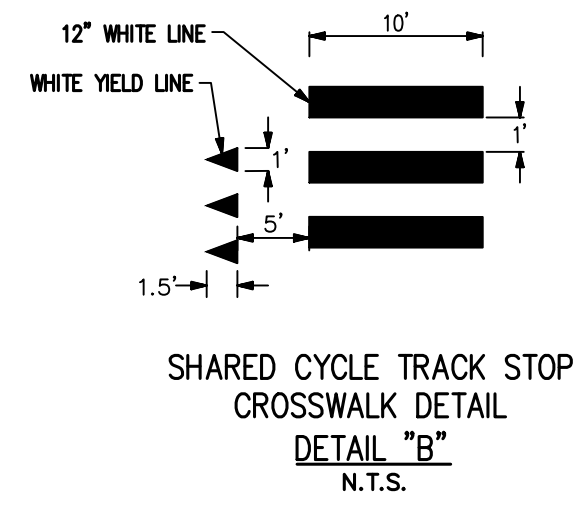
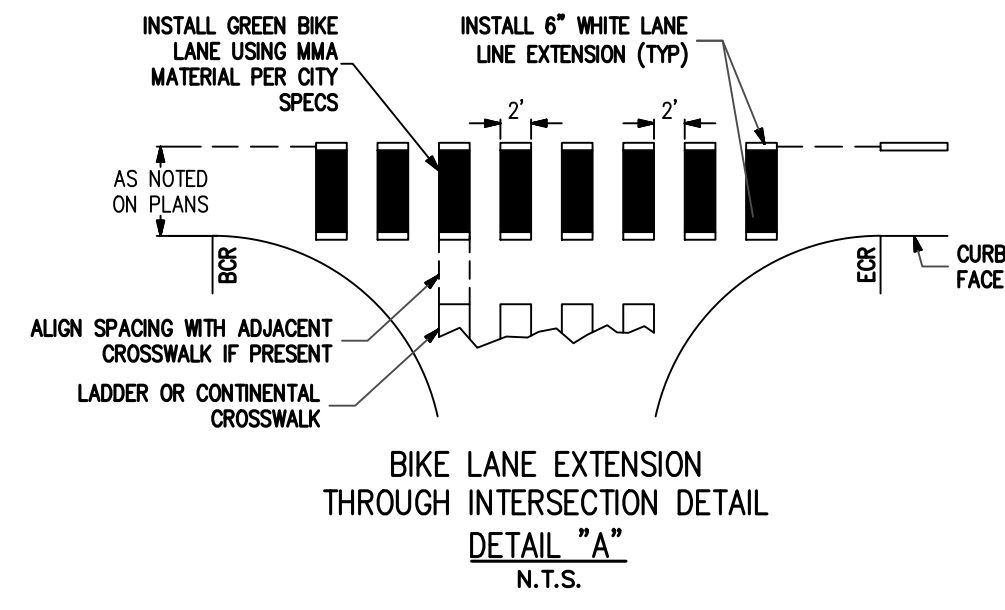

CITY OF CULVER CITY
PUBLIC WORKS DEPARTMENT
MOBILITY & TRAFFIC ENGINEERING DIVISION
FOX HILLS BIKEWAY IMPROVEMENTS PROJECT
STRIPING DETAIL SHEET



NO	DESCRIPTION	BY	AP	DATE



PLANS PREPARED BY:
WILLDAN Engineering extending your reach
13191 CROSSROADS PARKWAY NORTH
SUITE 405 INDUSTRY, CA 91746-3497
(662) 908-8200
UNDER THE SUPERVISION OF
JEFFREY C. LAU RCE 83887 DATE 12/12/24

DESIGNED BY MT	DATE 12/12/24	CHECKED BY THOMAS CHECK, PE, TE SENIOR TRAFFIC ENGINEER	DATE	SHEET 3	PROJECT NUMBER	PLAN NUMBER
DRAWN BY MT	DATE 12/12/24	APPROVED BY ANDREW MAXIMOUS, PE, TE MOBILITY & TRAFFIC ENGINEERING MANAGER	DATE	OF 11 SHEETS		

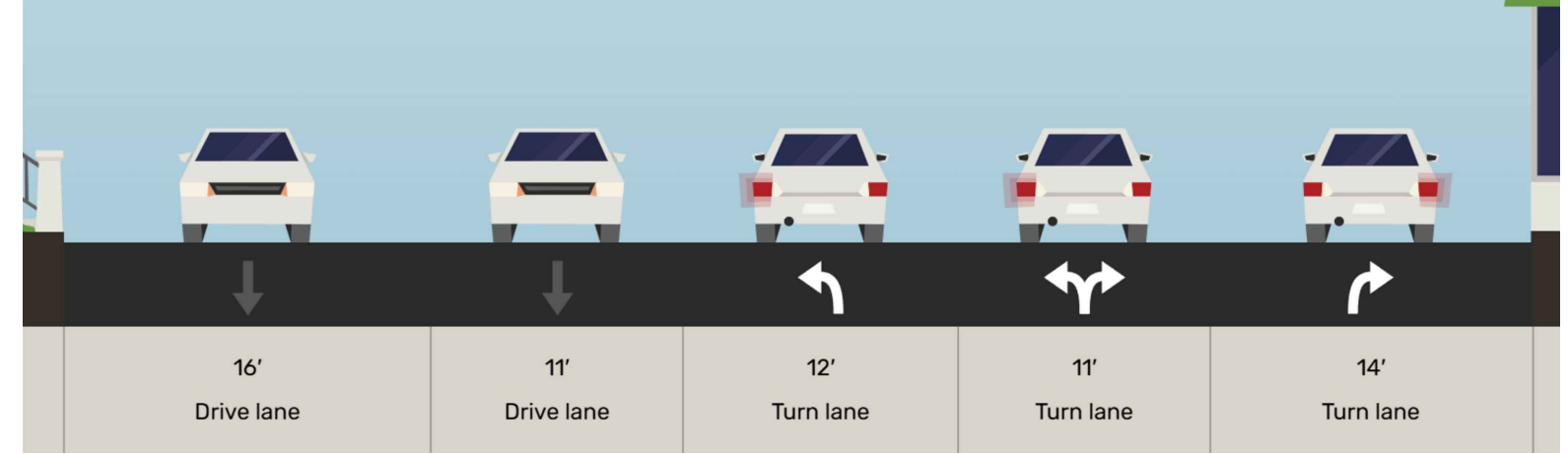
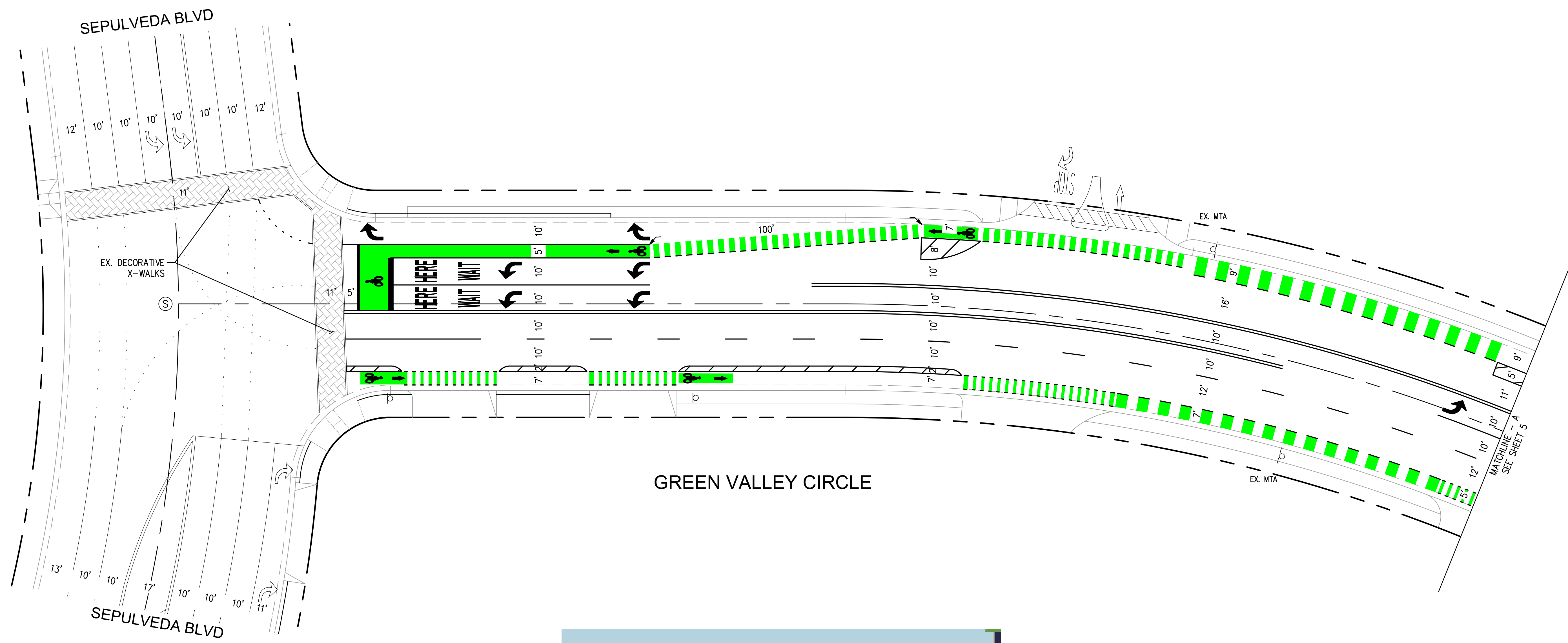

GREEN VALLEY CIR AT SEPULVEDA BLVD
EXISTING STREET CROSS SECTION

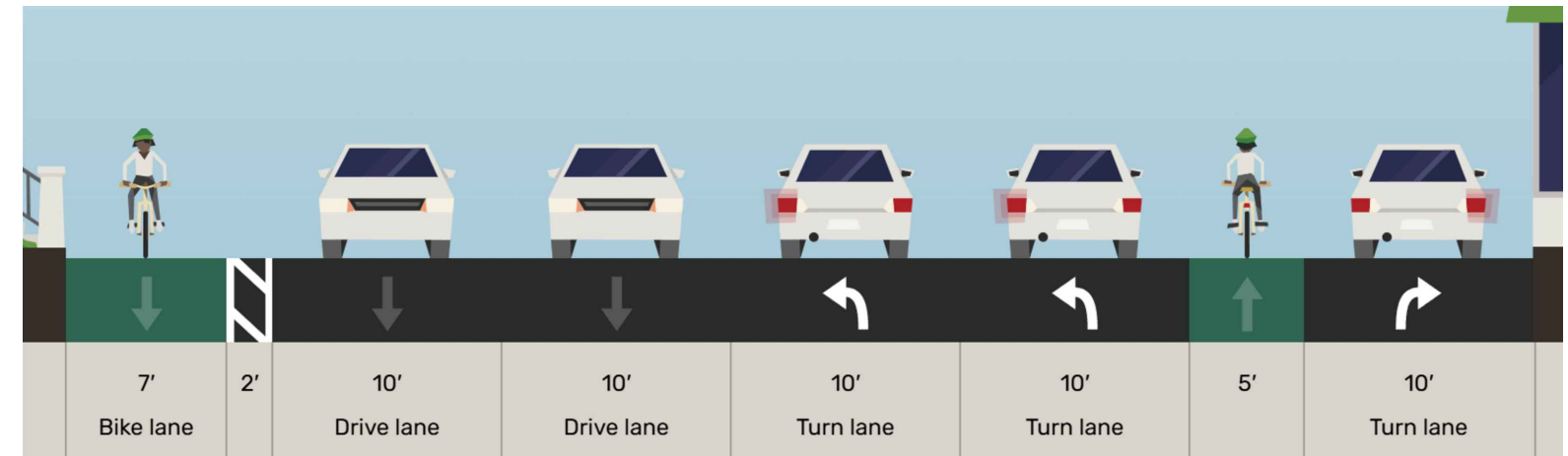

GREEN VALLEY CIR AT SEPULVEDA BLVD
PROPOSED STREET CROSS SECTION

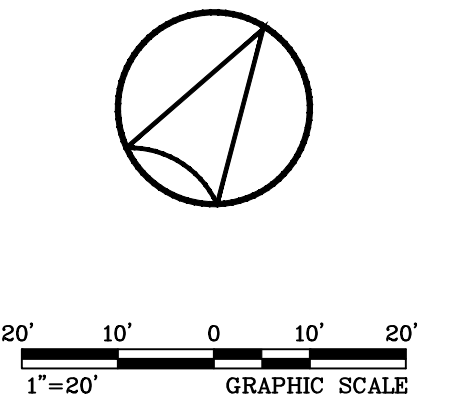

CITY OF CULVER CITY
PUBLIC WORKS DEPARTMENT
MOBILITY & TRAFFIC ENGINEERING DIVISION
FOX HILLS BIKEWAY IMPROVEMENTS PROJECT
CLASS II & IV BIKEWAY CONCEPT PLAN - A
GREEN VALLEY CIRCLE
FROM SEPULVEDA BLVD TO CENTINELA AVE



NO	DESCRIPTION	BY	AP	DATE



PLANS PREPARED BY:
WILLDAN Engineering *extending your reach*
13191 CROSSROADS PARKWAY NORTH
SUITE 405 INDUSTRY, CA 91746-3497
(662) 908-8200
UNDER THE SUPERVISION OF
JEFFREY C. LAU RCE 83887 DATE 12/12/24

DESIGNED BY MT	DATE 12/12/24	CHECKED BY THOMAS CHECK, PE, TE SENIOR TRAFFIC ENGINEER	DATE	SHEET 4	PROJECT NUMBER	PLAN NUMBER
DRAWN BY MT	DATE 12/12/24	APPROVED BY ANDREW MAXIMOUS, PE, TE MOBILITY & TRAFFIC ENGINEERING MANAGER	DATE	OF 11 SHEETS		

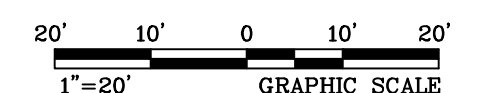
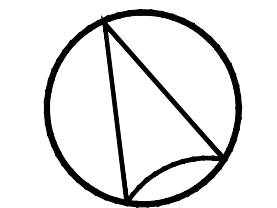
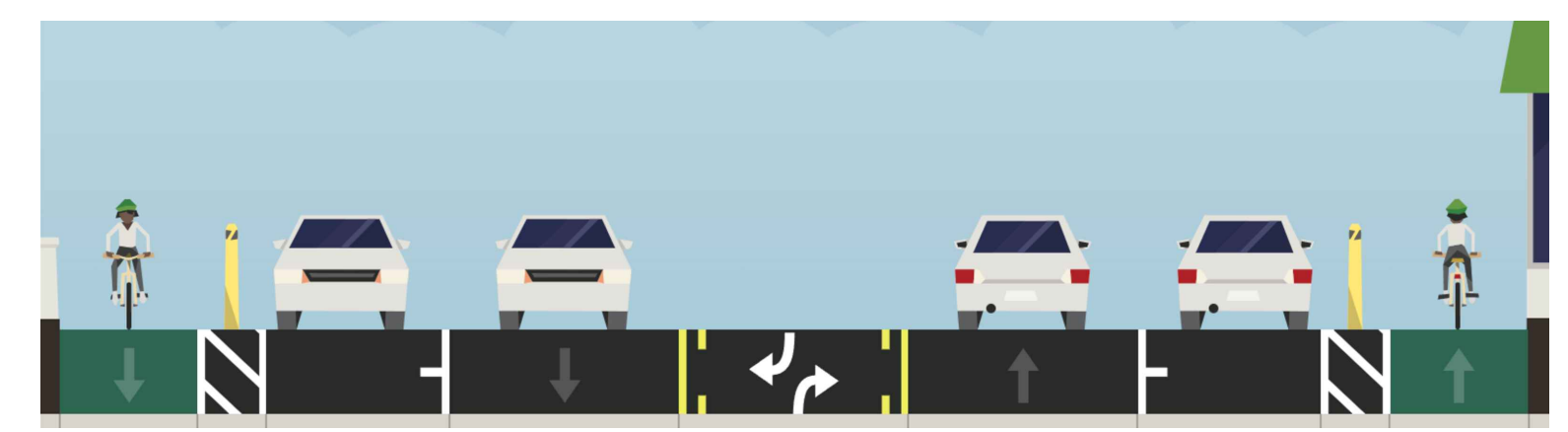
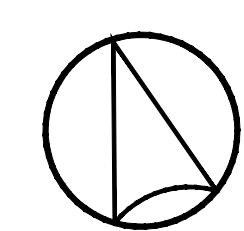
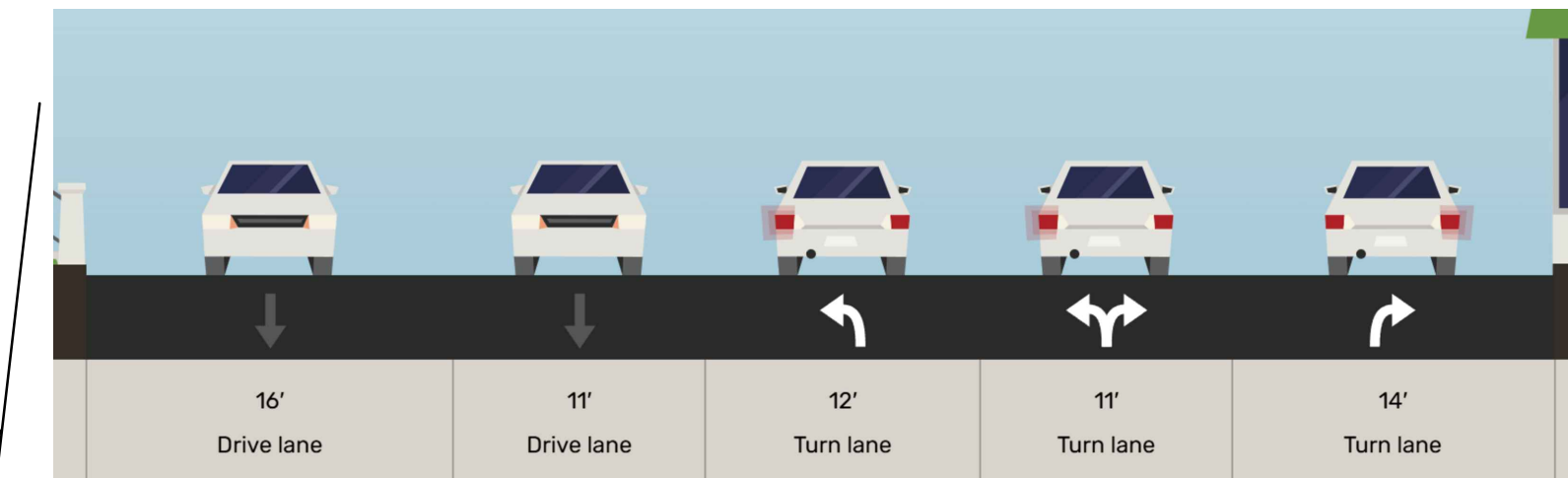
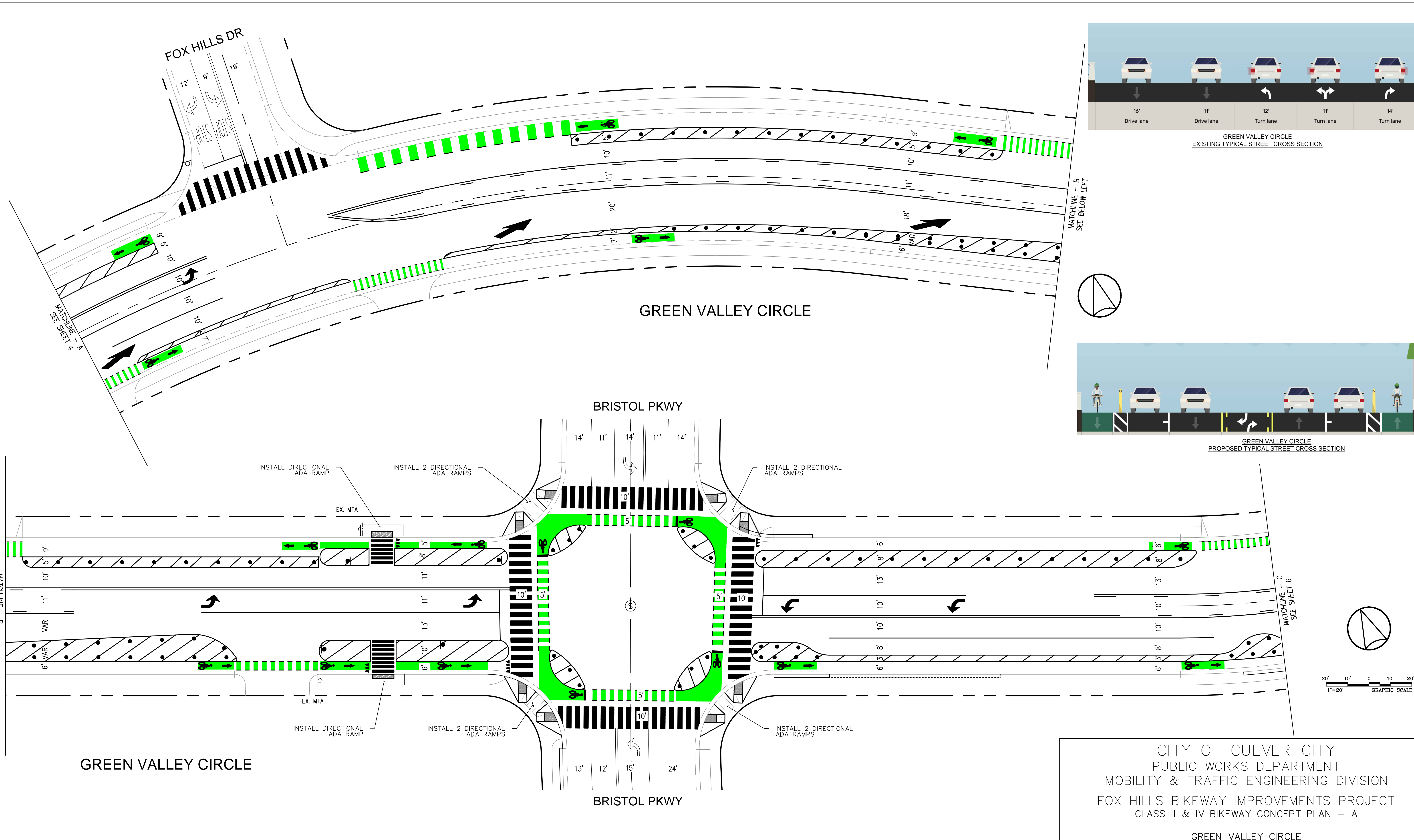

CITY OF CULVER CITY
PUBLIC WORKS DEPARTMENT
MOBILITY & TRAFFIC ENGINEERING DIVISION
FOX HILLS BIKEWAY IMPROVEMENTS PROJECT
CLASS II & IV BIKEWAY CONCEPT PLAN - A
GREEN VALLEY CIRCLE
FROM SEPULVEDA BLVD TO CENTINELA AVE



NO	DESCRIPTION	BY	AP	DATE



PLANS PREPARED BY:
WILLDAN Engineering *extending your reach*
13191 CROSSROADS PARKWAY NORTH
SUITE 405 INDUSTRY, CA 91746-3497
(662) 908-8200
UNDER THE SUPERVISION OF
JEFFREY C. LAU RCE 83887 DATE 12/12/24

DESIGNED BY MT	DATE 12/12/24	CHECKED BY THOMAS CHECK, PE, TE SENIOR TRAFFIC ENGINEER	DATE	SHEET 5	PROJECT NUMBER	PLAN NUMBER
DRAWN BY MT	DATE 12/12/24	APPROVED BY ANDREW MAXIMOUS, PE, TE MOBILITY & TRAFFIC ENGINEERING MANAGER	DATE	OF 11 SHEETS		

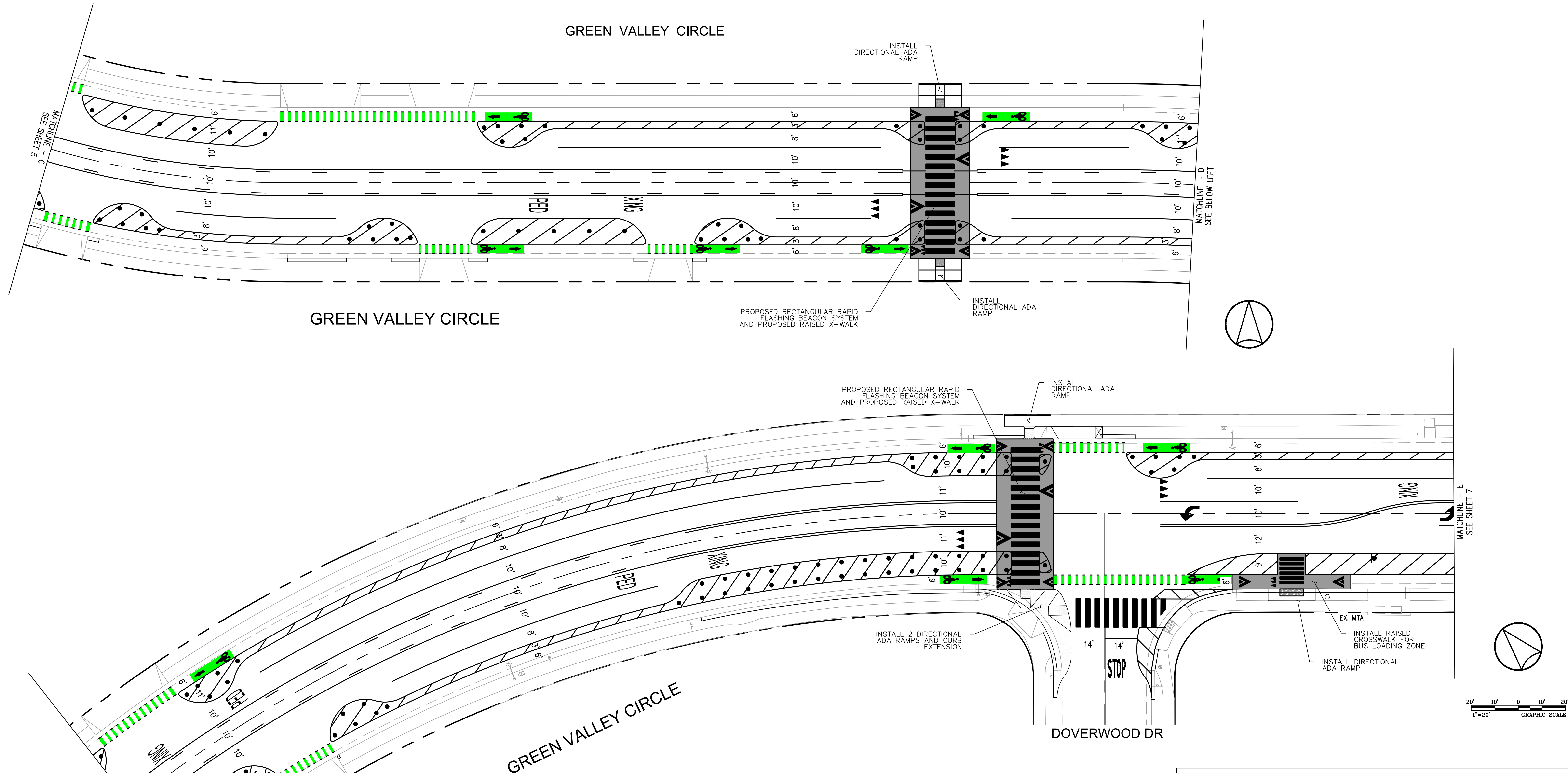

CITY OF CULVER CITY
PUBLIC WORKS DEPARTMENT
MOBILITY & TRAFFIC ENGINEERING DIVISION

FOX HILLS BIKEWAY IMPROVEMENTS PROJECT
CLASS II & IV BIKEWAY CONCEPT PLAN - A

GREEN VALLEY CIRCLE
FROM SEPULVEDA BLVD TO CENTINELA AVE

DESIGNED BY MT	DATE 12/12/24	CHECKED BY THOMAS CHECK, PE, TE SENIOR TRAFFIC ENGINEER	DATE	SHEET 6	PROJECT NUMBER	PLAN NUMBER
DRAWN BY MT	DATE 12/12/24	APPROVED BY ANDREW MAXIMOUS, PE, TE MOBILITY & TRAFFIC ENGINEERING MANAGER	DATE	OF 11 SHEETS		



NO	DESCRIPTION	BY	AP	DATE



PLANS PREPARED BY:
WILLDAN Engineering *extending your reach*
13191 CROSSROADS PARKWAY NORTH
SUITE 405 INDUSTRY, CA 91746-3497
(662) 908-8200

UNDER THE SUPERVISION OF
JEFFREY C. LAU RCE 83887 DATE 12/12/24

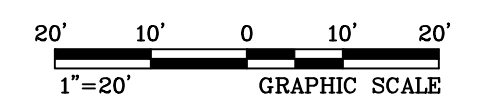
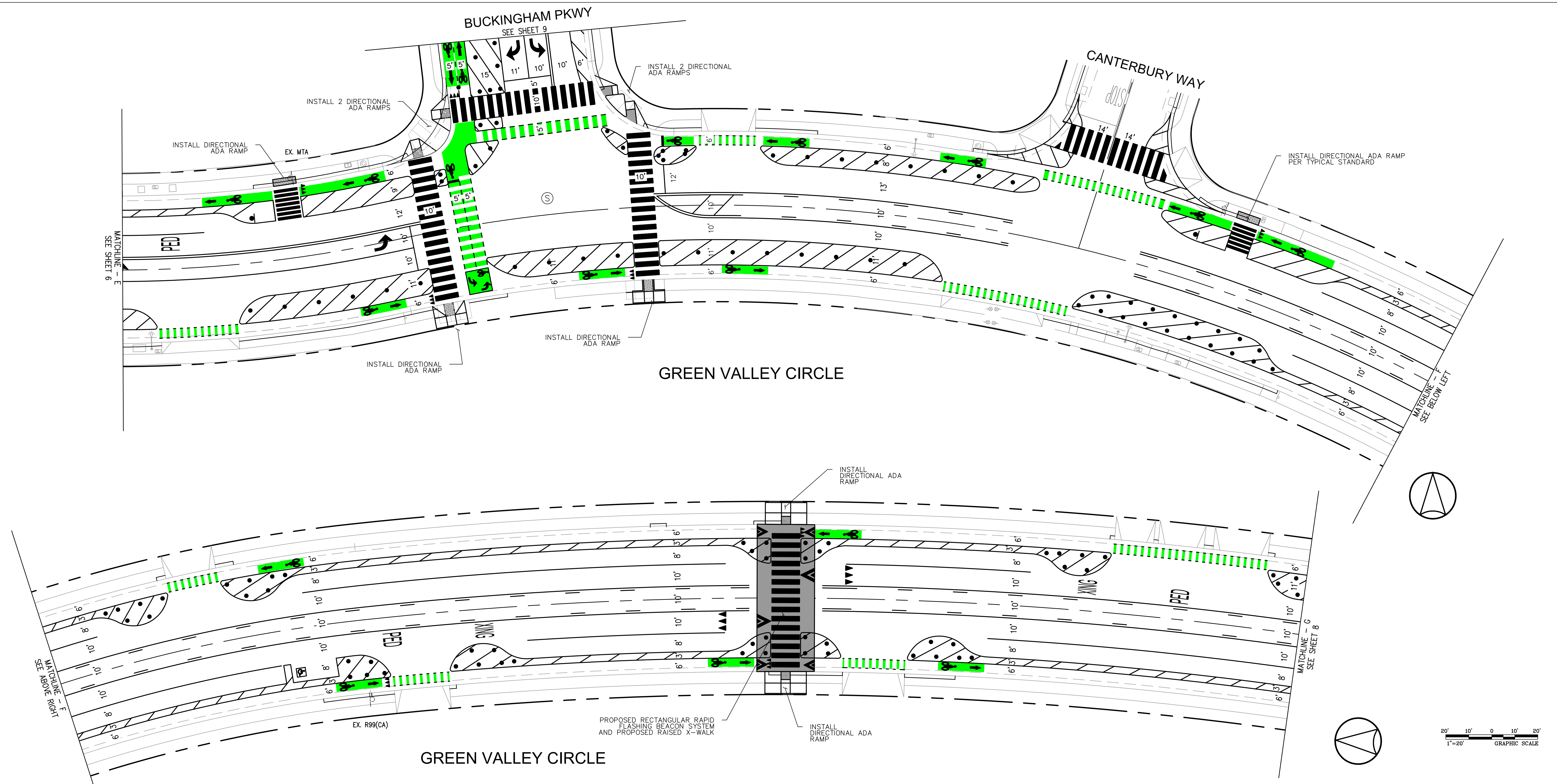

CITY OF CULVER CITY
PUBLIC WORKS DEPARTMENT
MOBILITY & TRAFFIC ENGINEERING DIVISION

FOX HILLS BIKEWAY IMPROVEMENTS PROJECT
CLASS II & IV BIKEWAY CONCEPT PLAN - A

GREEN VALLEY CIRCLE
FROM SEPULVEDA BLVD TO CENTINELA AVE

DESIGNED BY MT	DATE 12/12/24	CHECKED BY THOMAS CHECK, PE, TE SENIOR TRAFFIC ENGINEER	DATE	SHEET 7	PROJECT NUMBER	PLAN NUMBER
DRAWN BY MT	DATE 12/12/24	APPROVED BY ANDREW MAXIMOUS, PE, TE MOBILITY & TRAFFIC ENGINEERING MANAGER	DATE	OF 11 SHEETS		



NO	DESCRIPTION	BY	AP	DATE



PLANS PREPARED BY:
WILLDAN Engineering *extending your reach*
13191 CROSSROADS PARKWAY NORTH
SUITE 405 INDUSTRY, CA 91746-3497
(662) 909-8200

UNDER THE SUPERVISION OF
JEFFREY C. LAU RCE 83887 DATE 12/12/24

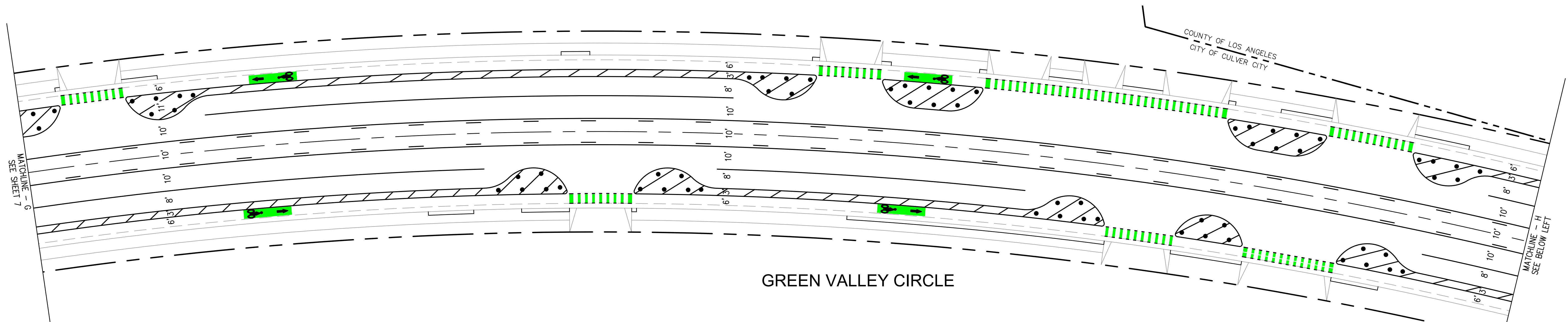

GREEN VALLEY CIRCLE

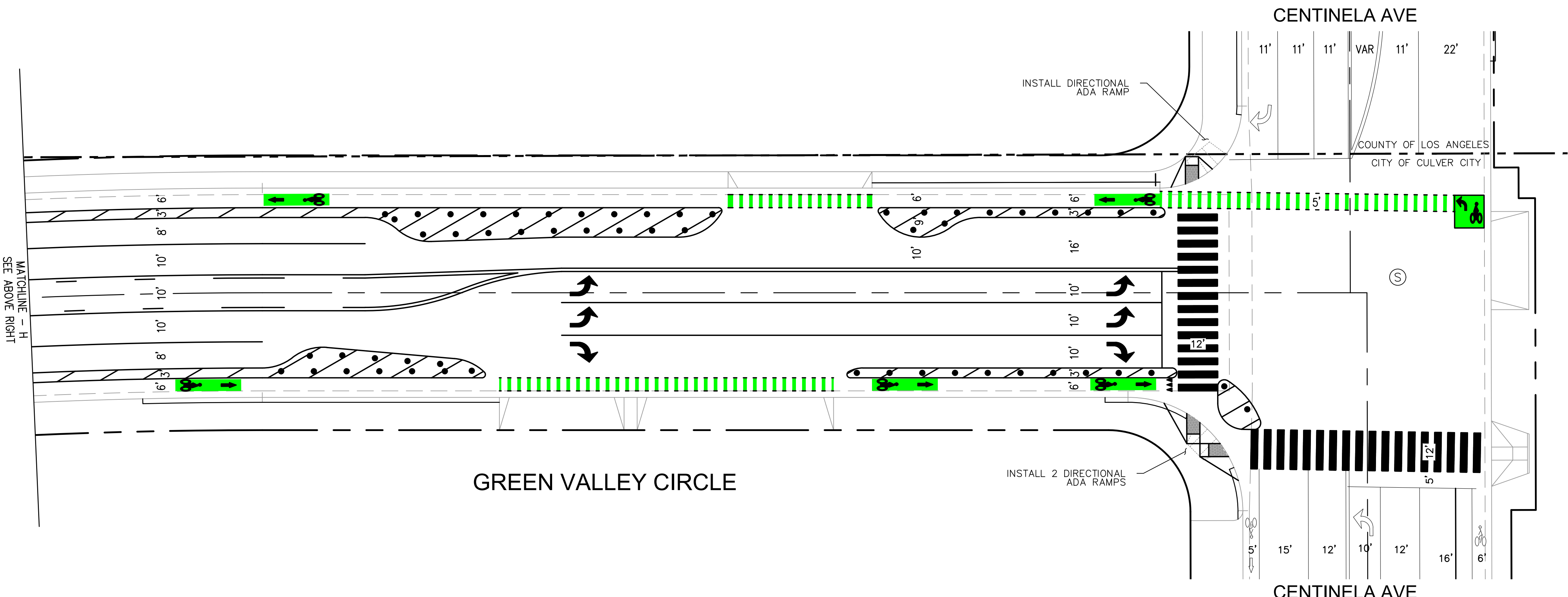

GREEN VALLEY CIRCLE

CENTINELA AVE

CENTINELA AVE

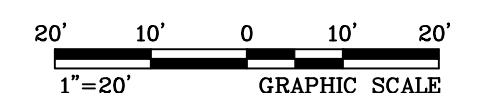

CITY OF CULVER CITY
 PUBLIC WORKS DEPARTMENT
 MOBILITY & TRAFFIC ENGINEERING DIVISION
 FOX HILLS BIKEWAY IMPROVEMENTS PROJECT
 CLASS II & IV BIKEWAY CONCEPT PLAN - A
 GREEN VALLEY CIRCLE
 FROM SEPULVEDA BLVD TO CENTINELA AVE



NO	DESCRIPTION	BY	AP	DATE



PLANS PREPARED BY:
WILLDAN Engineering *extending your reach*
 13191 CROSSROADS PARKWAY NORTH
 SUITE 405 INDUSTRY, CA 91746-3497
 (942) 908-8200
 UNDER THE SUPERVISION OF
 JEFFREY C. LAU RCE 83887 DATE 12/12/24

DESIGNED BY MT	DATE 12/12/24	CHECKED BY THOMAS CHECK, PE, TE SENIOR TRAFFIC ENGINEER	DATE	SHEET 8	PROJECT NUMBER	PLAN NUMBER
DRAWN BY MT	DATE 12/12/24	APPROVED BY ANDREW MAXIMOUS, PE, TE MOBILITY & TRAFFIC ENGINEERING MANAGER	DATE	OF 11 SHEETS		

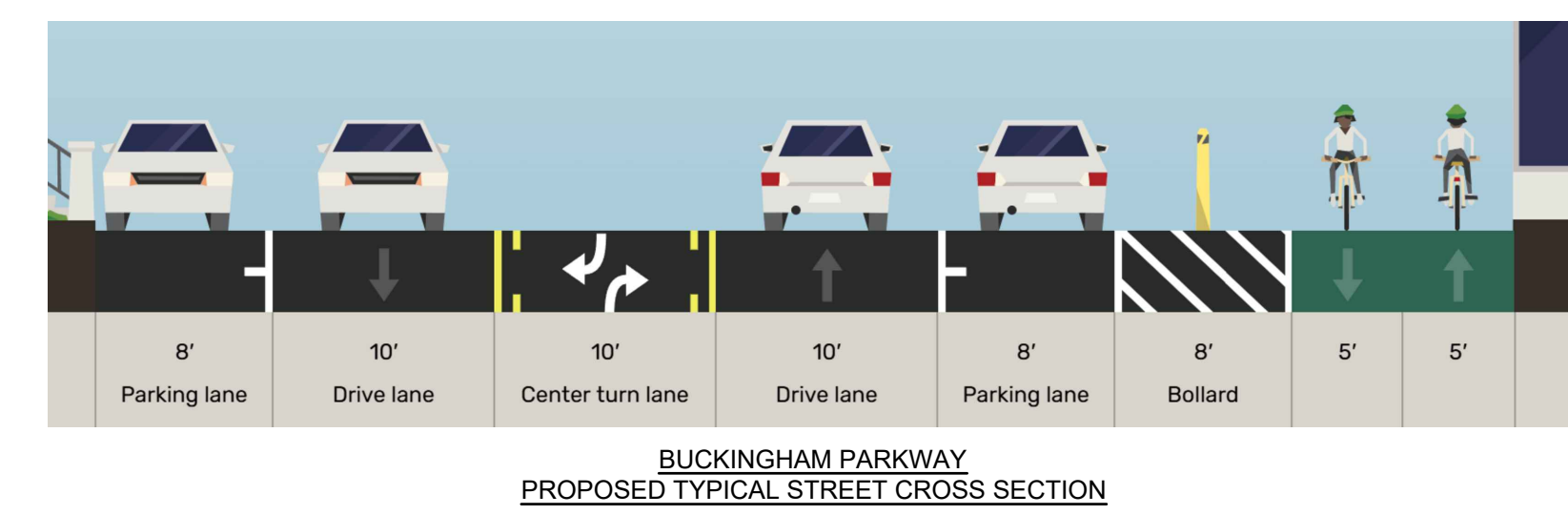
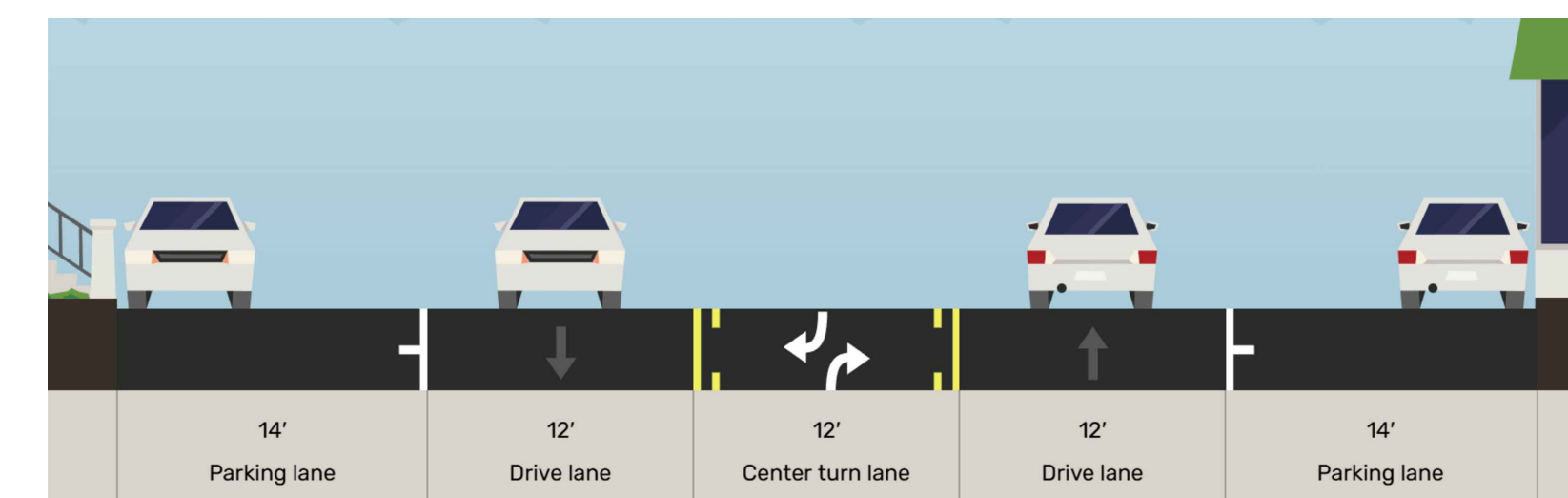
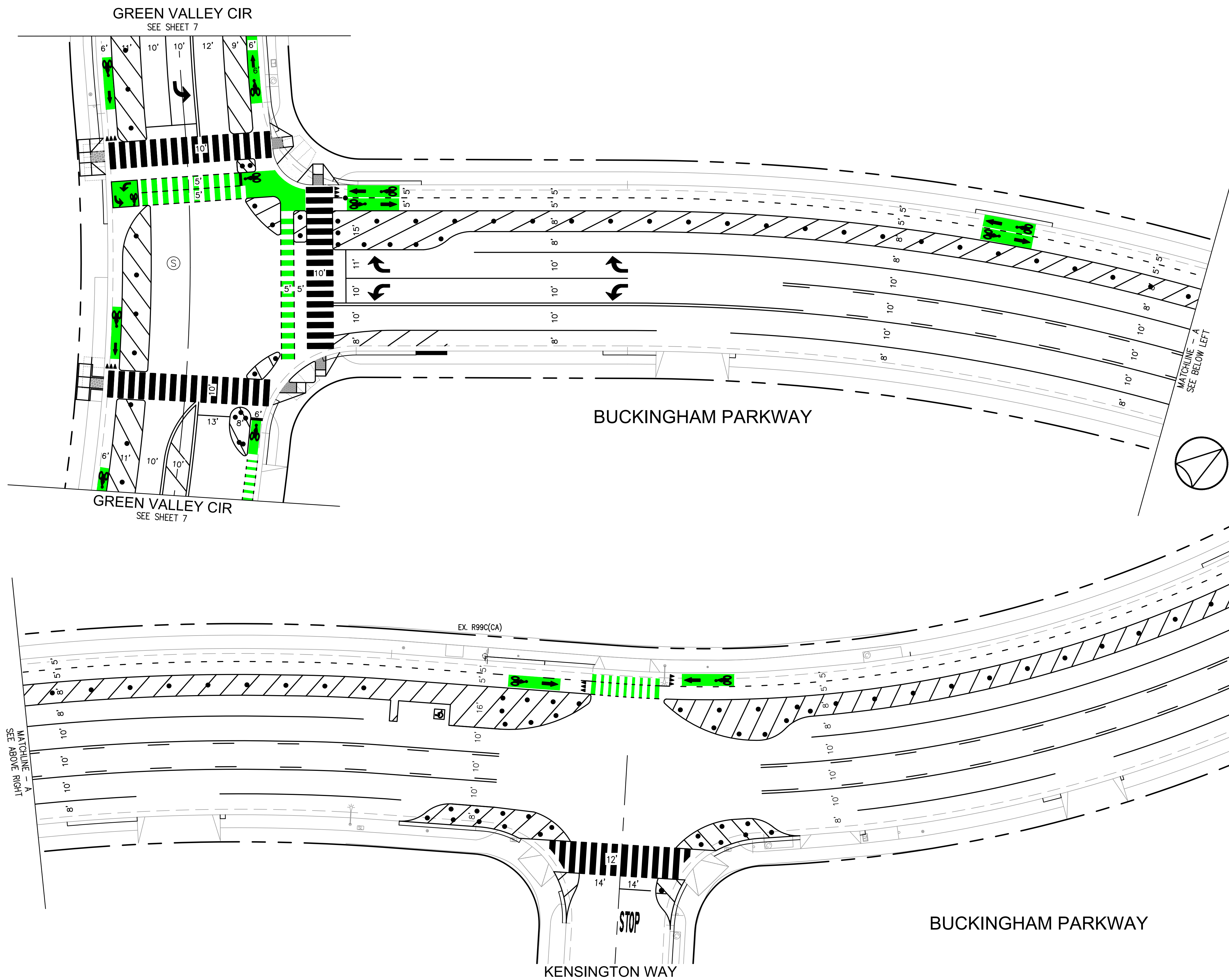

CITY OF CULVER CITY
 PUBLIC WORKS DEPARTMENT
 MOBILITY & TRAFFIC ENGINEERING DIVISION
 FOX HILLS BIKEWAY IMPROVEMENTS PROJECT
 CLASS IV BIKEWAY CONCEPT PLAN - A
 BUCKINGHAM PARKWAY
 FROM GREEN VALLEY CIR TO HANNUM AVE



NO	DESCRIPTION	BY	AP	DATE

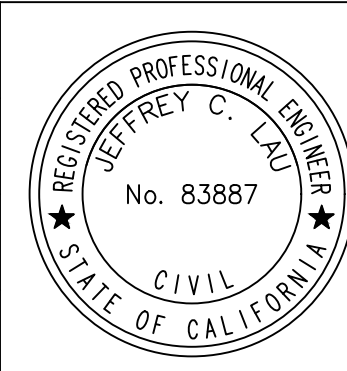

PLANS PREPARED BY:
WILLDAN Engineering extending your reach
 13191 CROSSROADS PARKWAY NORTH
 SUITE 405 INDUSTRY, CA 91746-3497
 (662) 908-8200
 UNDER THE SUPERVISION OF
 JEFFREY C. LAU RCE 83887 DATE 12/12/24

DESIGNED BY MT	DATE 12/12/24	CHECKED BY THOMAS CHECK, PE, TE SENIOR TRAFFIC ENGINEER	DATE	SHEET 9	PROJECT NUMBER	PLAN NUMBER
DRAWN BY MT	DATE 12/12/24	APPROVED BY ANDREW MAXIMOUS, PE, TE MOBILITY & TRAFFIC ENGINEERING MANAGER	DATE	OF 11 SHEETS		

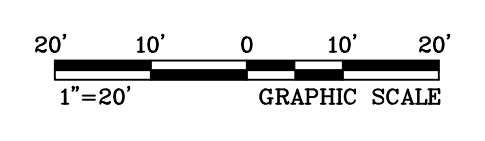
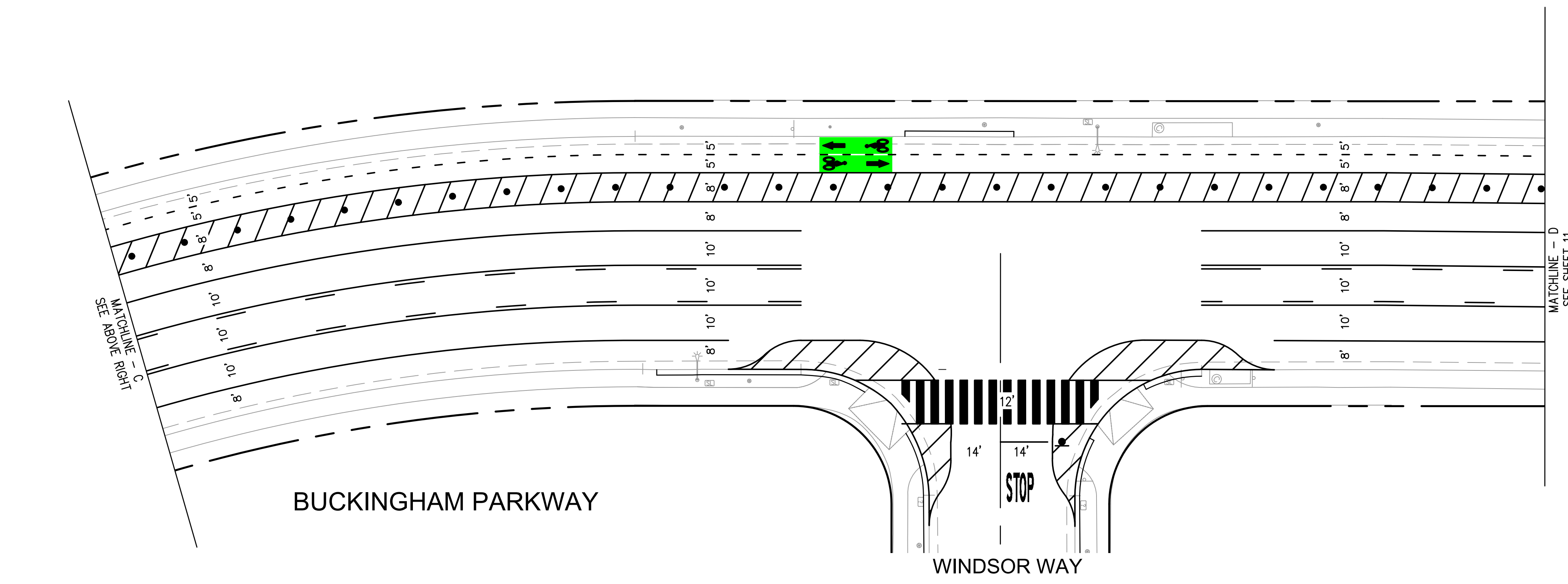
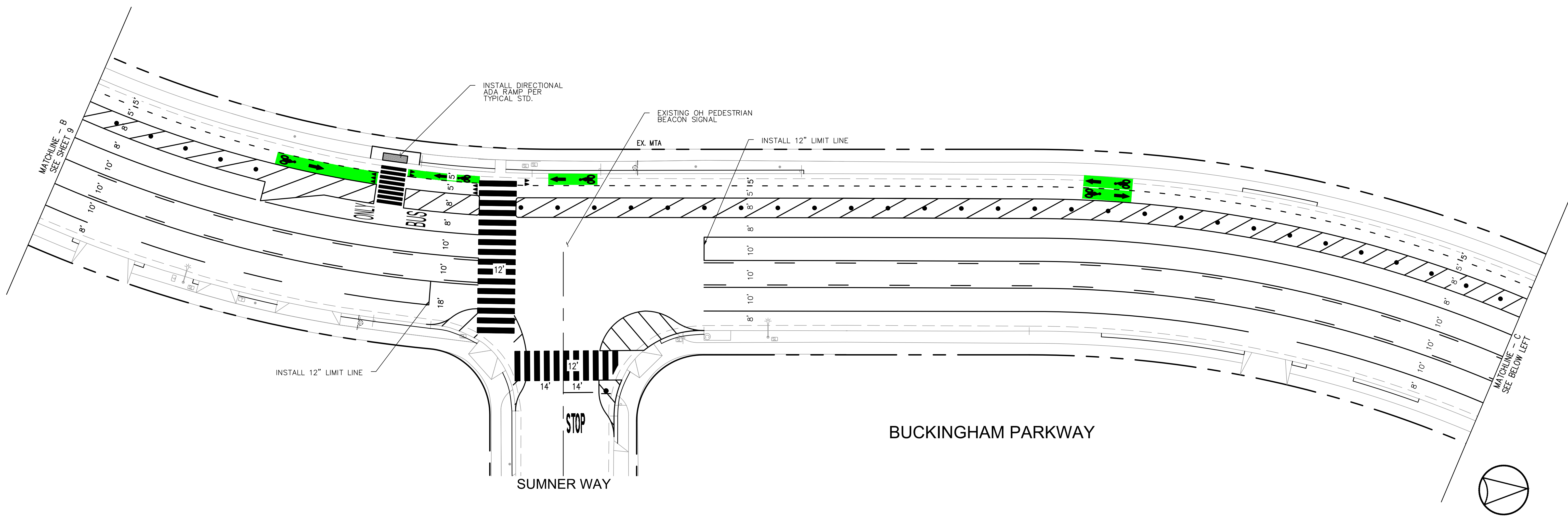

CITY OF CULVER CITY PUBLIC WORKS DEPARTMENT MOBILITY & TRAFFIC ENGINEERING DIVISION			
FOX HILLS BIKEWAY IMPROVEMENTS PROJECT CLASS IV BIKEWAY CONCEPT PLAN - A			
BUCKINGHAM PARKWAY FROM GREEN VALLEY CIR TO HANNUM AVE			
DESIGNED BY	DATE	CHECKED BY	SHEET
MT	12/12/24	THOMAS CHECK, PE, TE SENIOR TRAFFIC ENGINEER	10
DRAWN BY	DATE	APPROVED BY	OF
MT	12/12/24	ANDREW MAXIMOUS, PE, TE MOBILITY & TRAFFIC ENGINEERING MANAGER	11
			SHEETS
			PROJECT NUMBER
			PLAN NUMBER



NO	DESCRIPTION	BY	AP	DATE



PLANS PREPARED BY:
WILLDAN Engineering *extending your reach*
 13191 CROSSROADS PARKWAY NORTH
 SUITE 405 INDUSTRY, CA 91746-3497
 (662) 908-8200
 UNDER THE SUPERVISION OF
 JEFFREY C. LAU RCE 83887 DATE 12/12/24

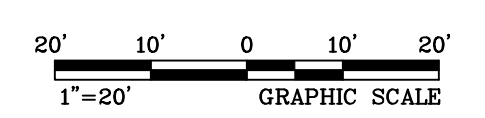
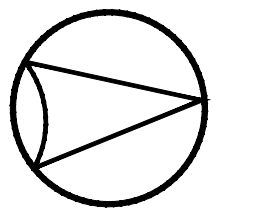
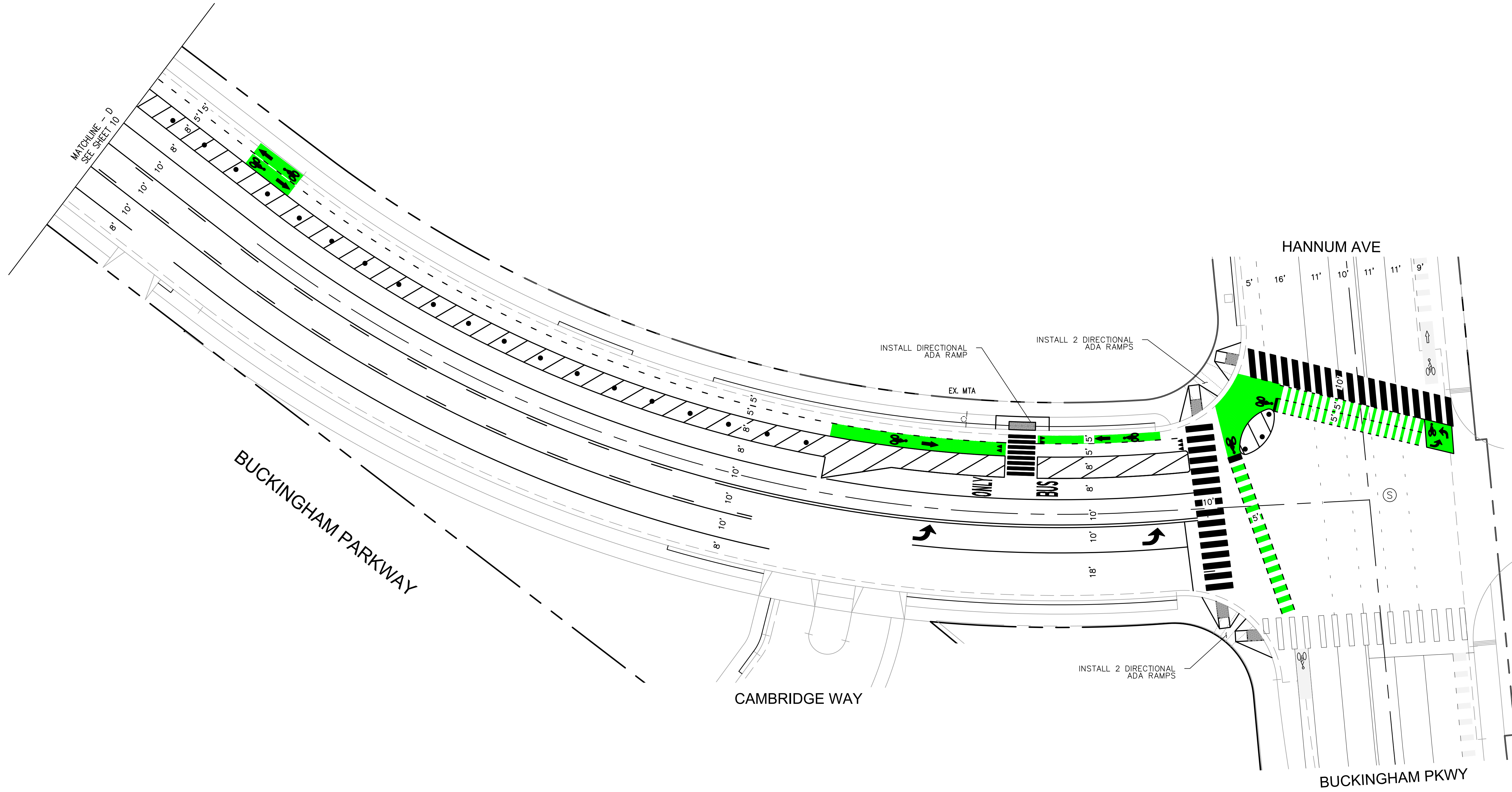

CITY OF CULVER CITY
PUBLIC WORKS DEPARTMENT
MOBILITY & TRAFFIC ENGINEERING DIVISION

FOX HILLS BIKEWAY IMPROVEMENTS PROJECT
CLASS IV BIKEWAY CONCEPT PLAN - A

BUCKINGHAM PARKWAY
FROM GREEN VALLEY CIR TO HANNUM AVE



NO	DESCRIPTION	BY	AP	DATE



PLANS PREPARED BY:
WILLDAN Engineering *extending your reach*
13191 CROSSROADS PARKWAY NORTH
SUITE 405 INDUSTRY, CA 91746-3497
(662) 908-8200

UNDER THE SUPERVISION OF
JEFFREY C. LAU RCE 83887 DATE 12/12/24

DESIGNED BY MT	DATE 12/12/24	CHECKED BY THOMAS CHECK, PE, TE SENIOR TRAFFIC ENGINEER	DATE	SHEET 11	PROJECT NUMBER	PLAN NUMBER
DRAWN BY MT	DATE 12/12/24	APPROVED BY ANDREW MAXIMOUS, PE, TE MOBILITY & TRAFFIC ENGINEERING MANAGER	DATE	OF 11 SHEETS		